

Normal roof

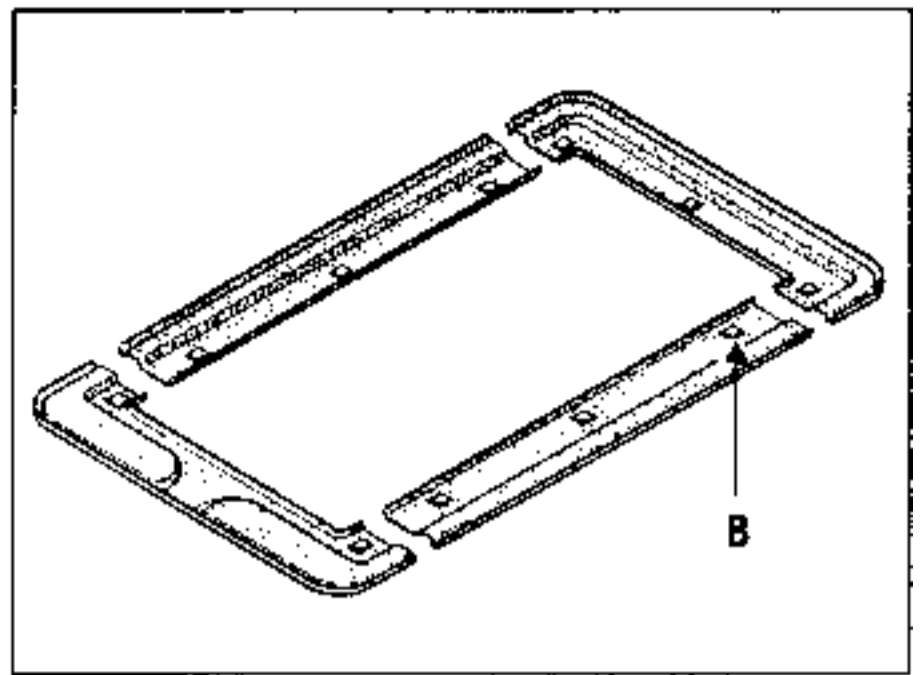

Sun roof

REMOVAL - REFITTING

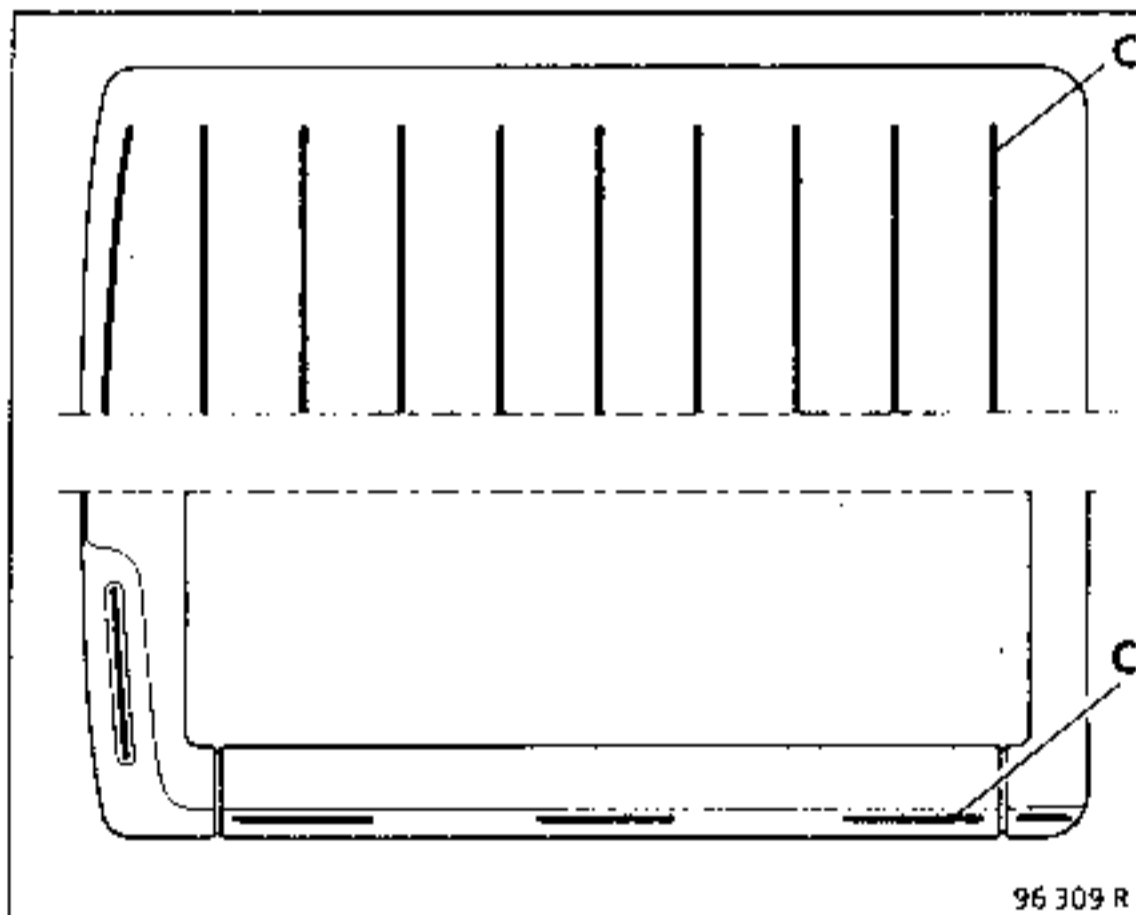

Diagram showing position of adhesive beads

Normal roof:

Protect the seats with a cover.
Remove the lining with a knife (mastic knife). If the lining is being removed and then refitted, level off the adhesive beads.
Stick the roof lining into place as shown above using 4 mm diameter adhesive beads (single pot Gurit type adhesive mastic).
Fit the roof lining into position ensuring it is correctly centred.

Sun roof:

The lining is in four sections.
These are held in place using Velcro (B) and adhesive beads (single pot Gurit type adhesive mastic) (C).
When refitting, apply the adhesive beads as shown above.

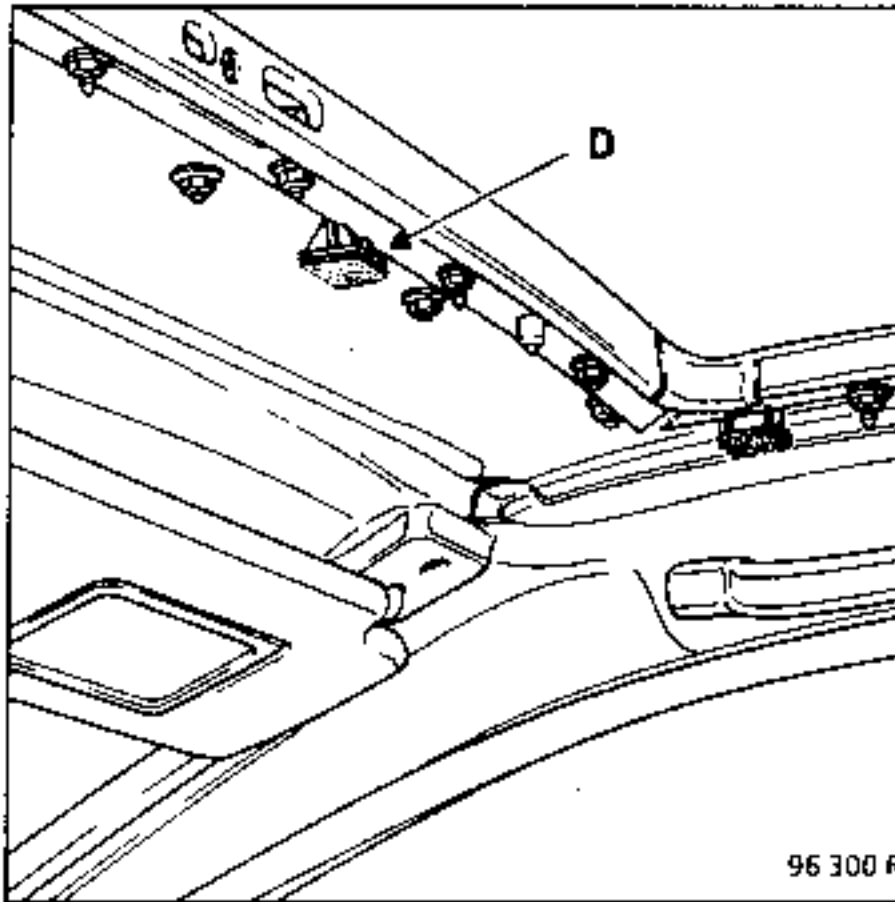

Refit the linings, using the Velcro to position the sections (D).
Press down on the parts where the adhesive beads are located

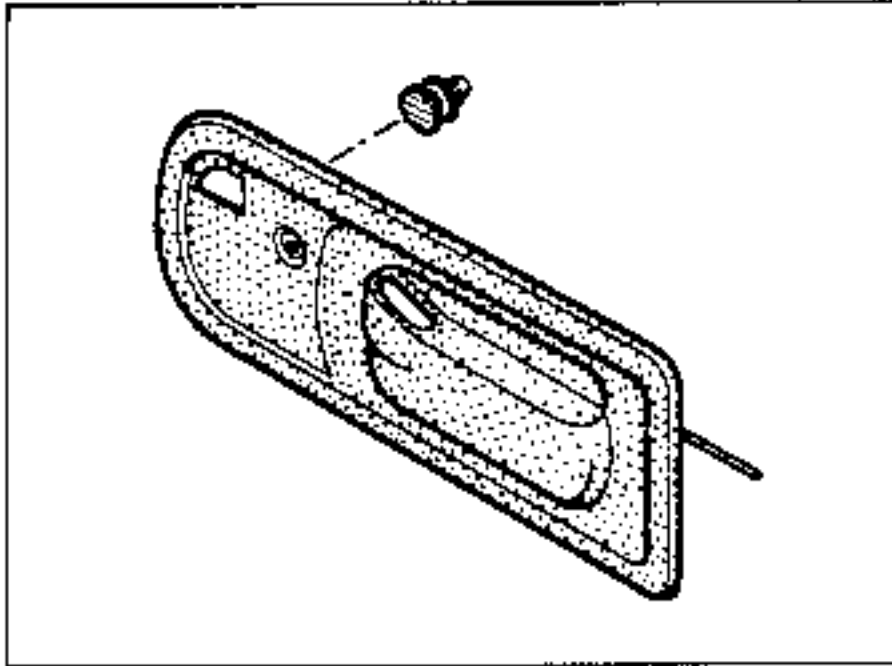

REMOVAL

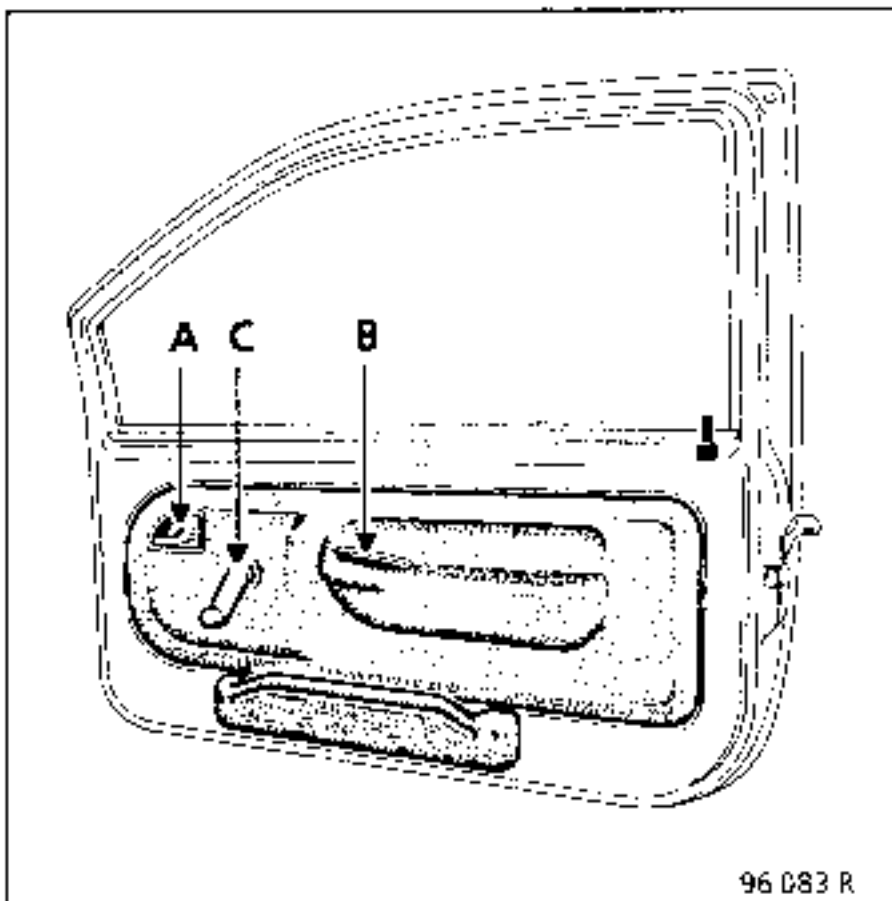

Remove:

- the opening handle (A)
- the pull handle (B)
- the window winder handle (C)
- the lining, taking care when cutting the mastic sealing bead.

When refitting, replace the mastic sealing bead
(see N.T. 219 A)

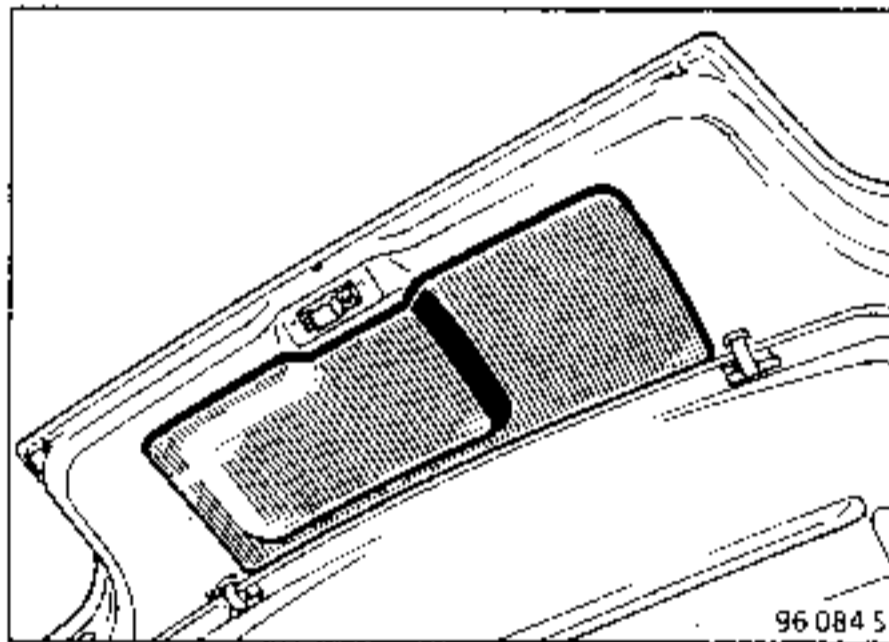
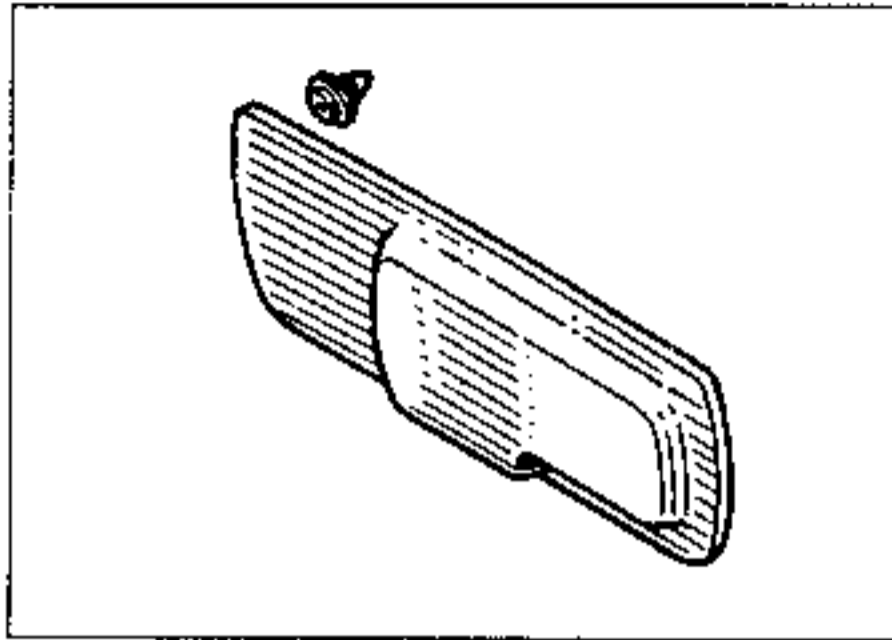

Unclip the lining, cutting the mastic sealing bead.

When refitting, replace the mastic sealing bead
(see N.T. 219 A).

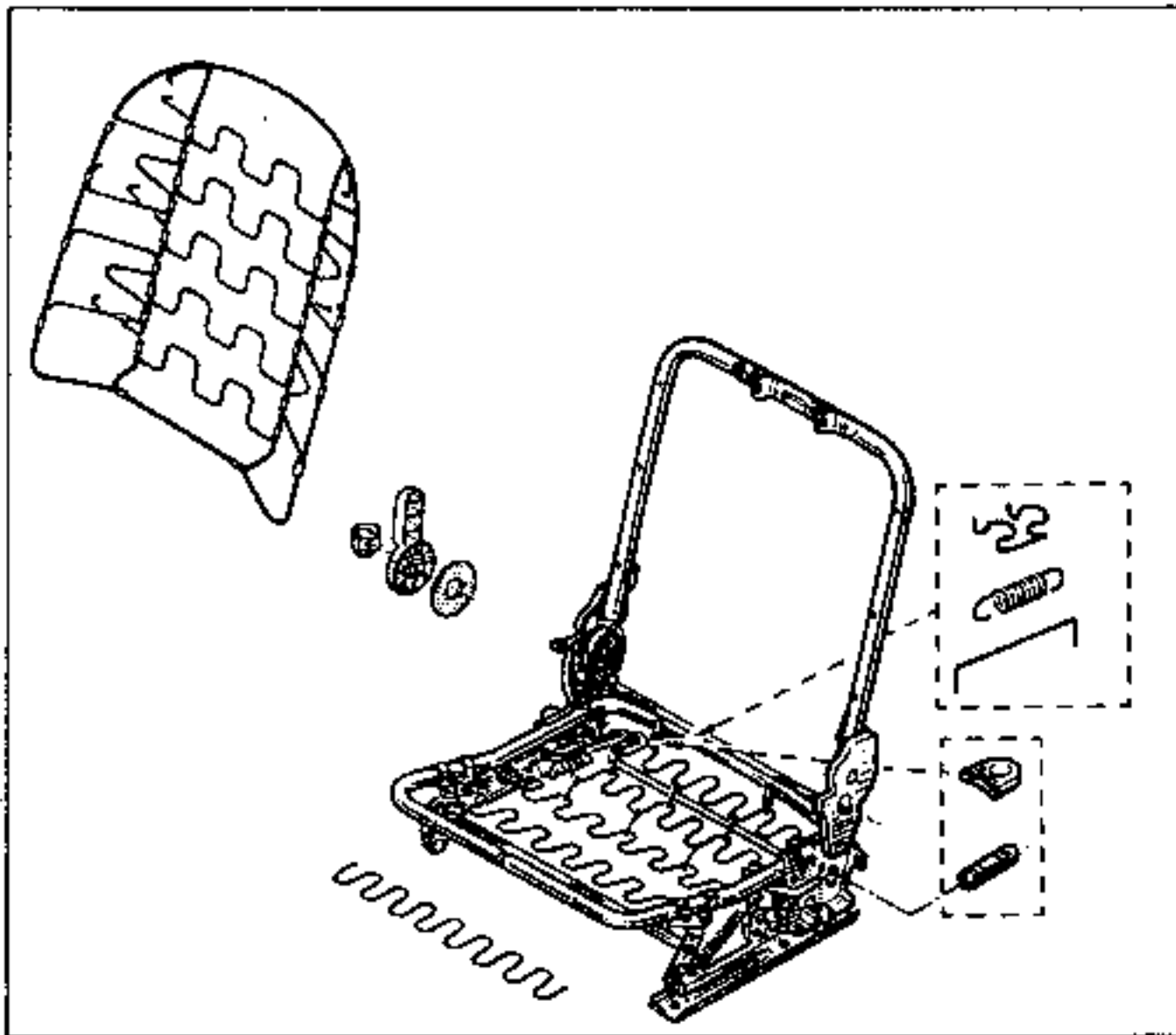

REMOVAL (Two possibilities)

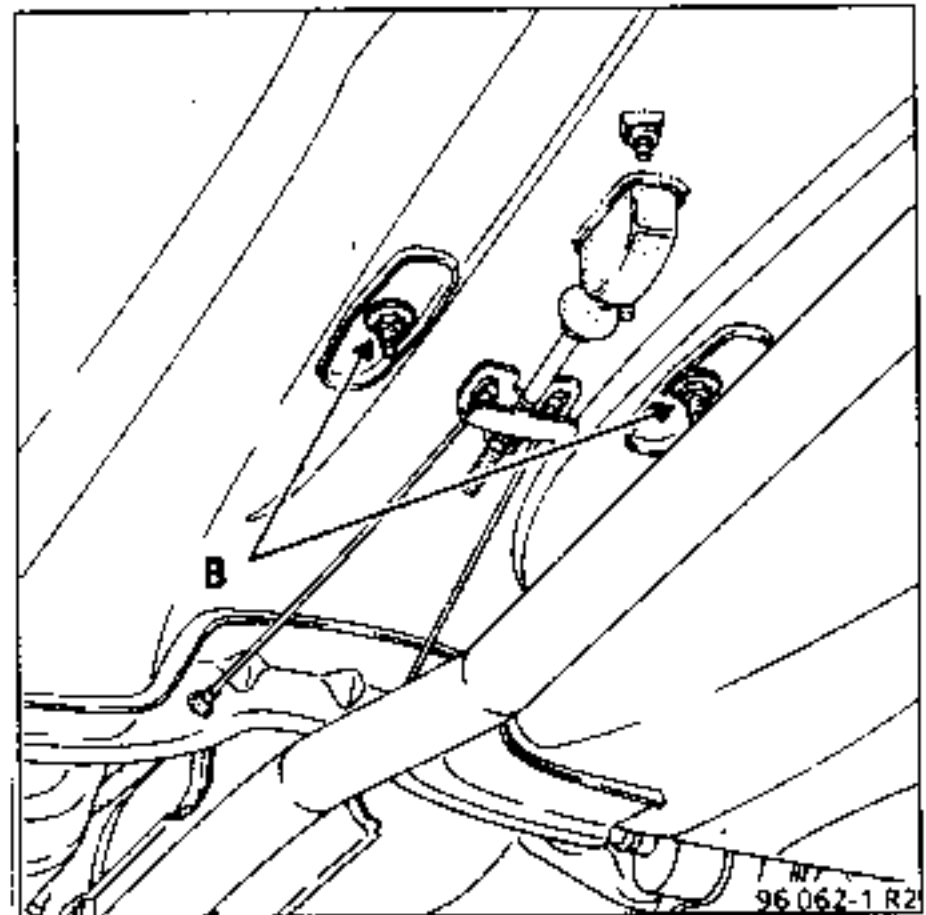
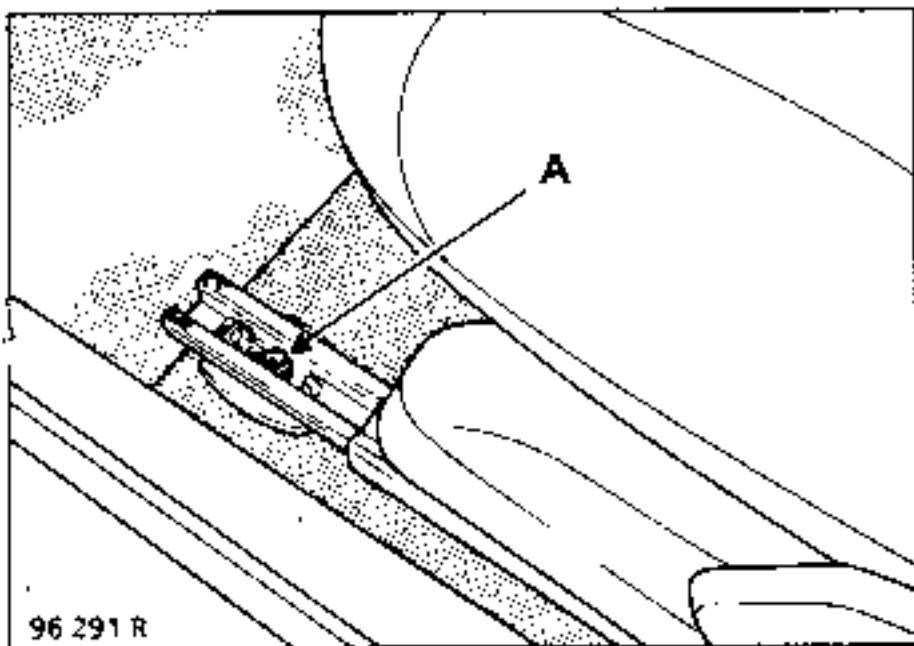

1

Remove:

- the side mountings (A)
- the central mountings under the body (B)

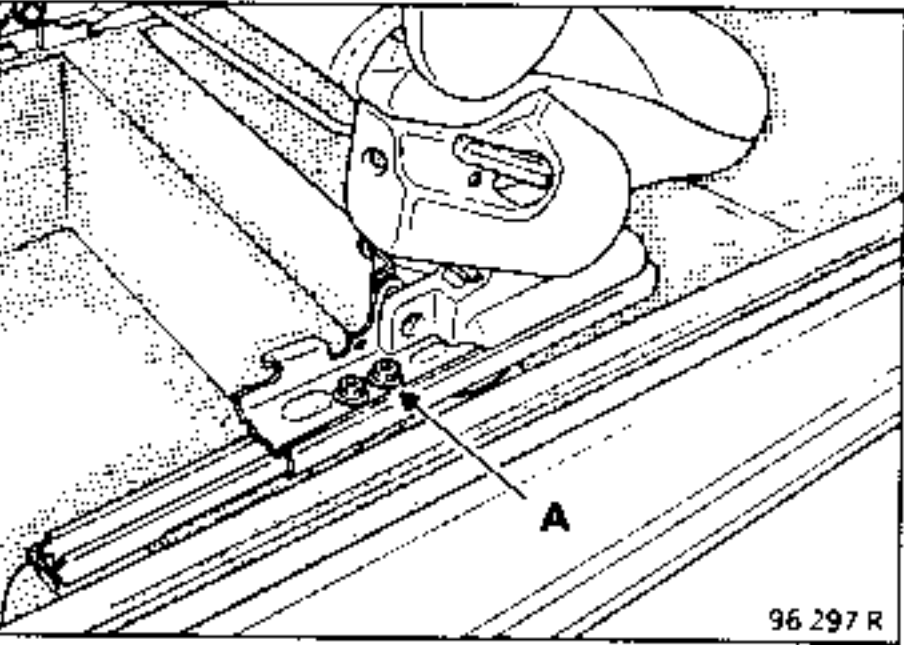
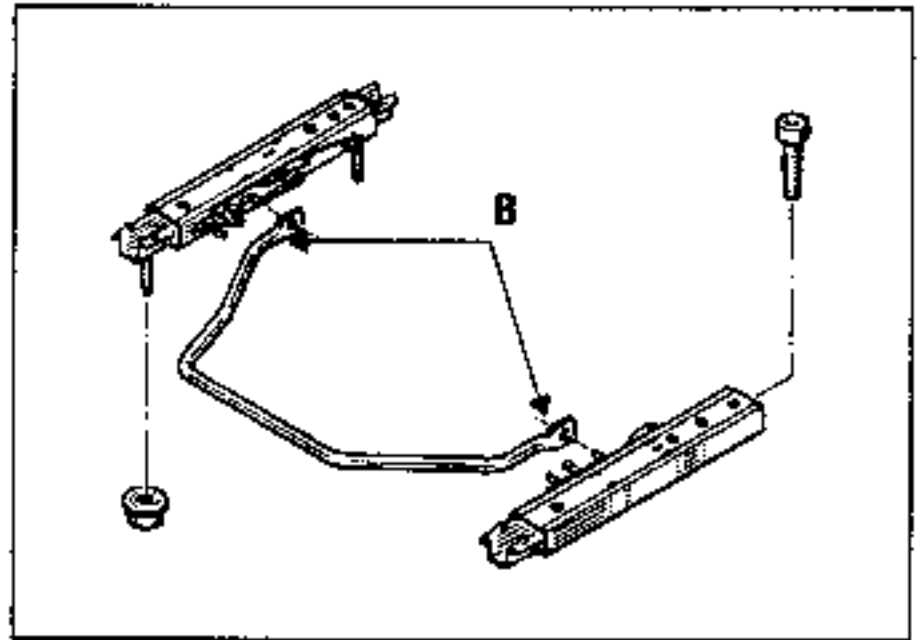
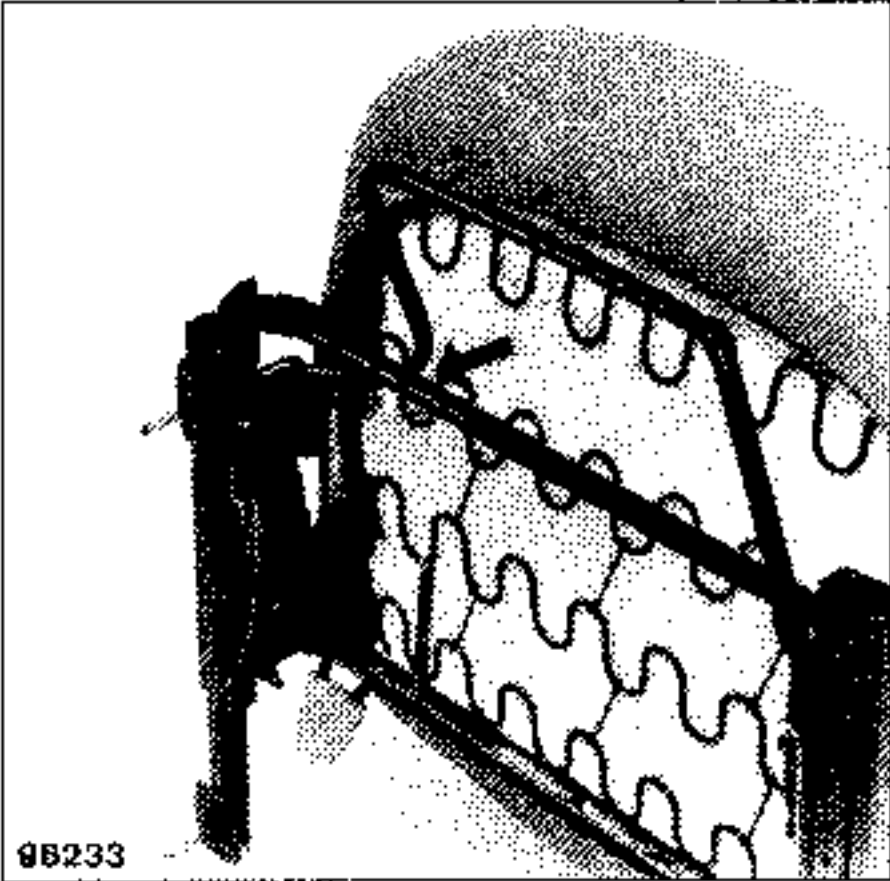

- ② Unclip the linkage (see photo) and (B).
- Remove the runner bolts (A).

REMOVAL

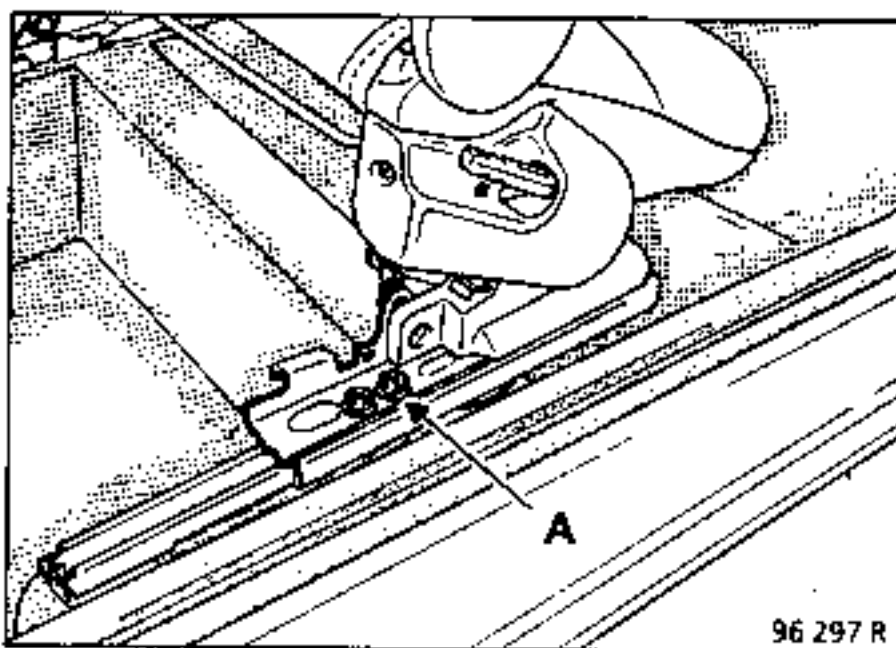
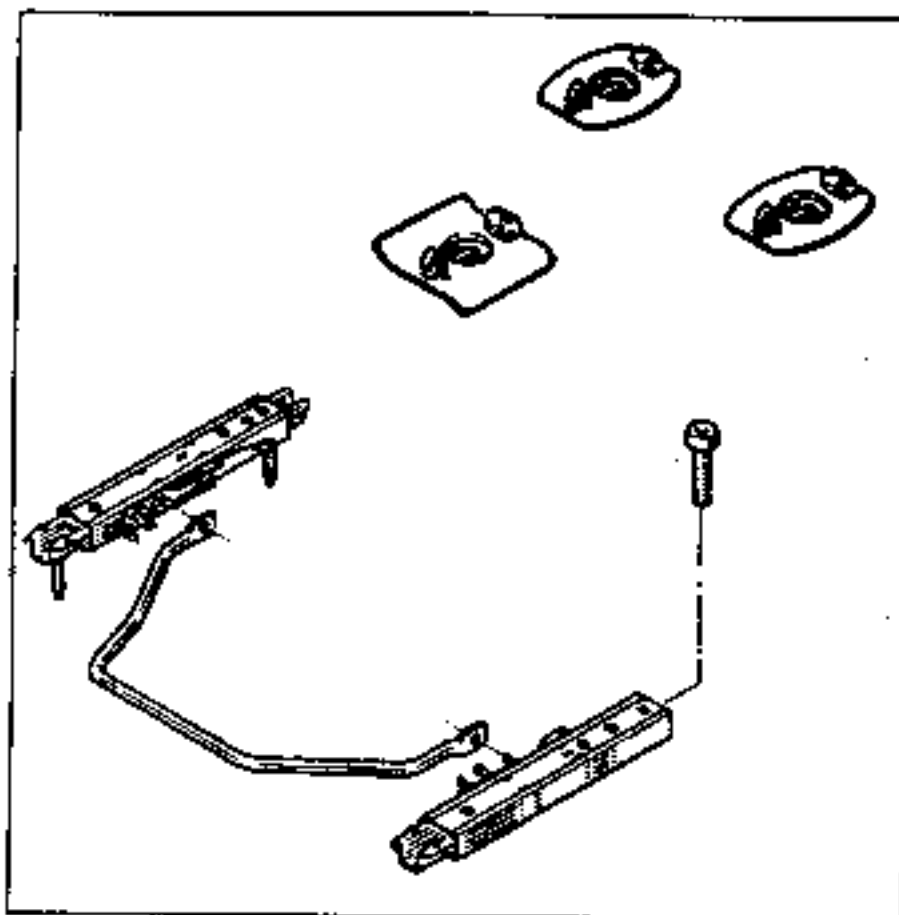

After removing the seat, remove the runner (A).

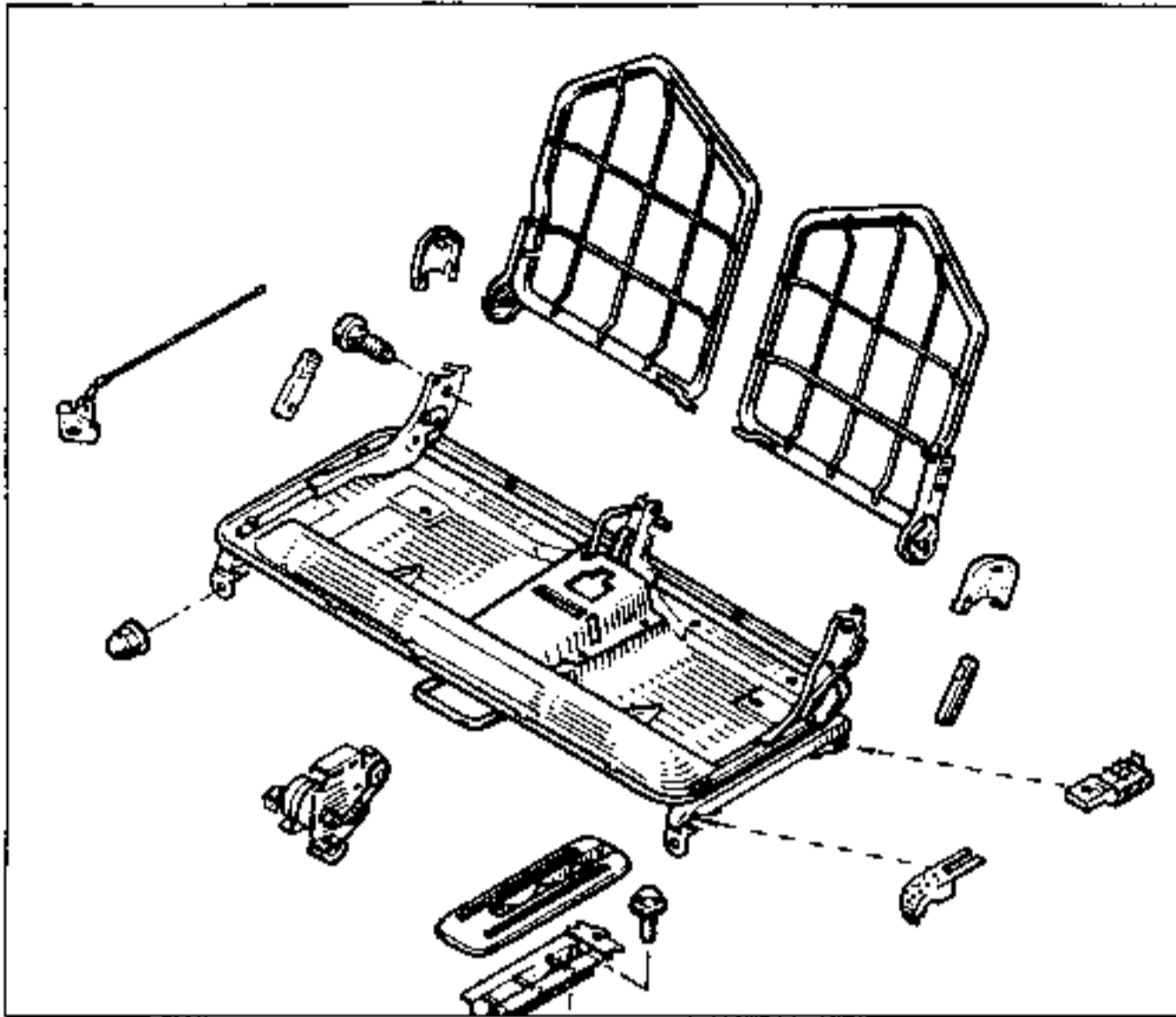

IMPORTANT : If the vehicle has been subject to a heavy impact which could have altered the geometry of the rear bench seat, the seat frame must be replaced for safety reasons (jig accuracy and correct seat locking) . The seat frame is provided with the runners already fitted. For all removal and refitting work, the method and tightening torques specified must be followed.

REMOVAL

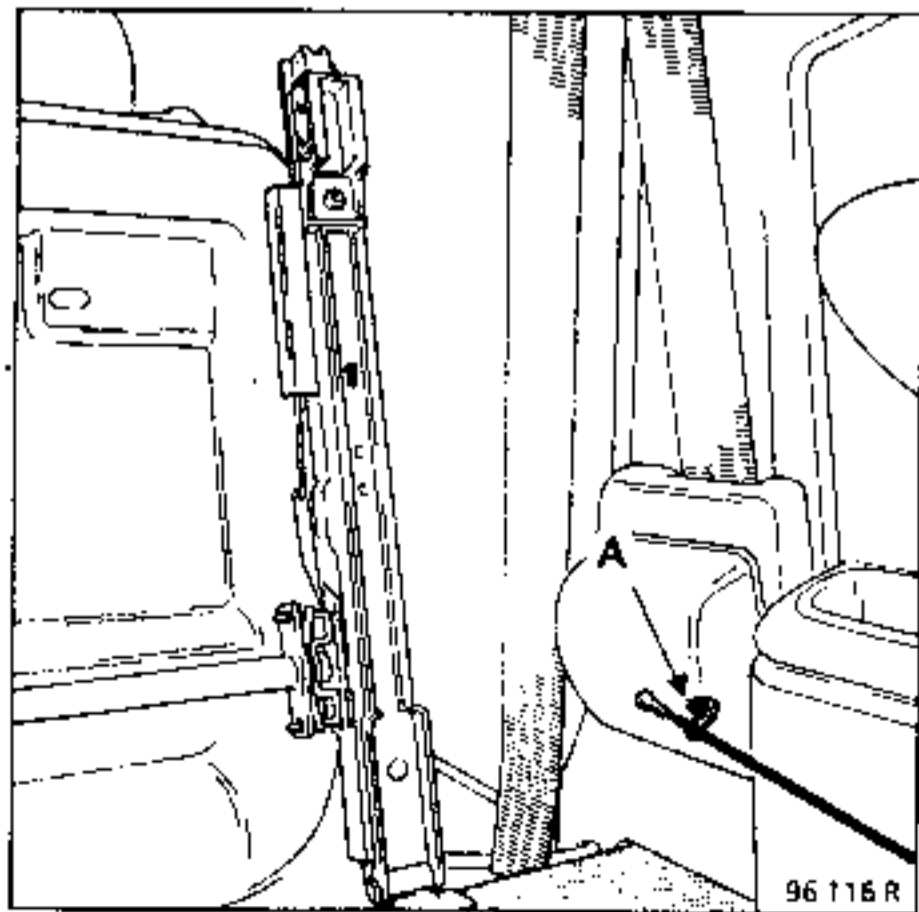

Having folded the seatback down onto the seat squab, tilt the seat forward and remove the retaining cable clips (A).

Unclip the cable and reposition the seats.

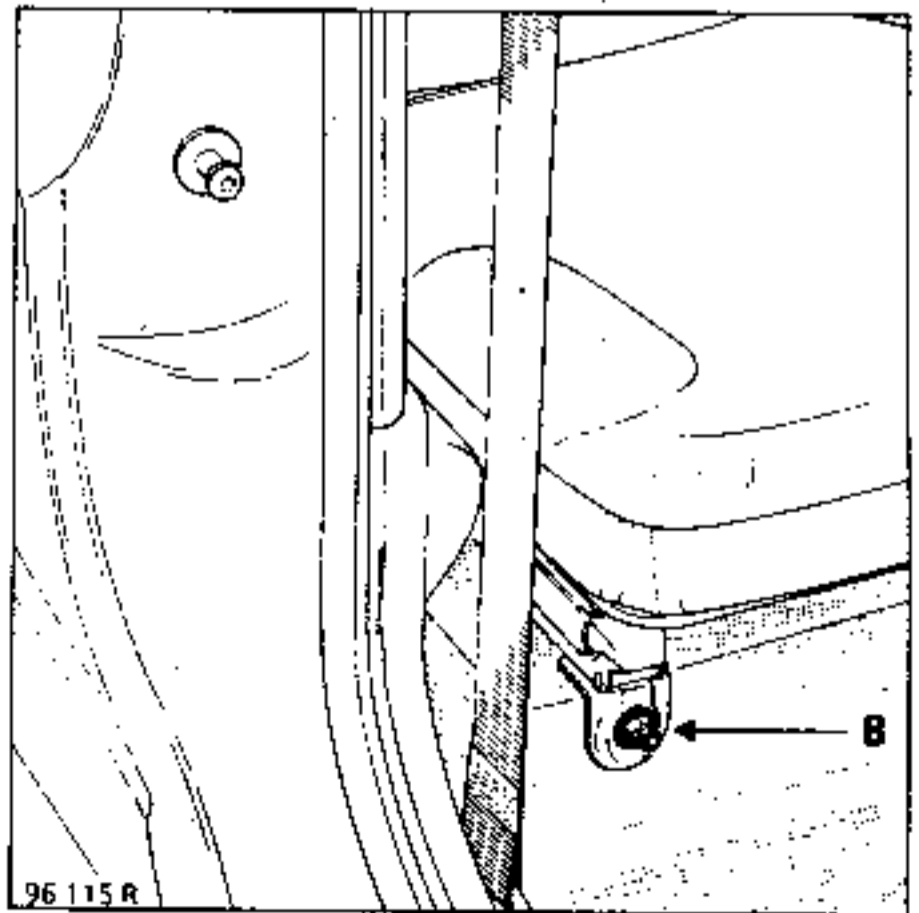

Remove the mountings (B)

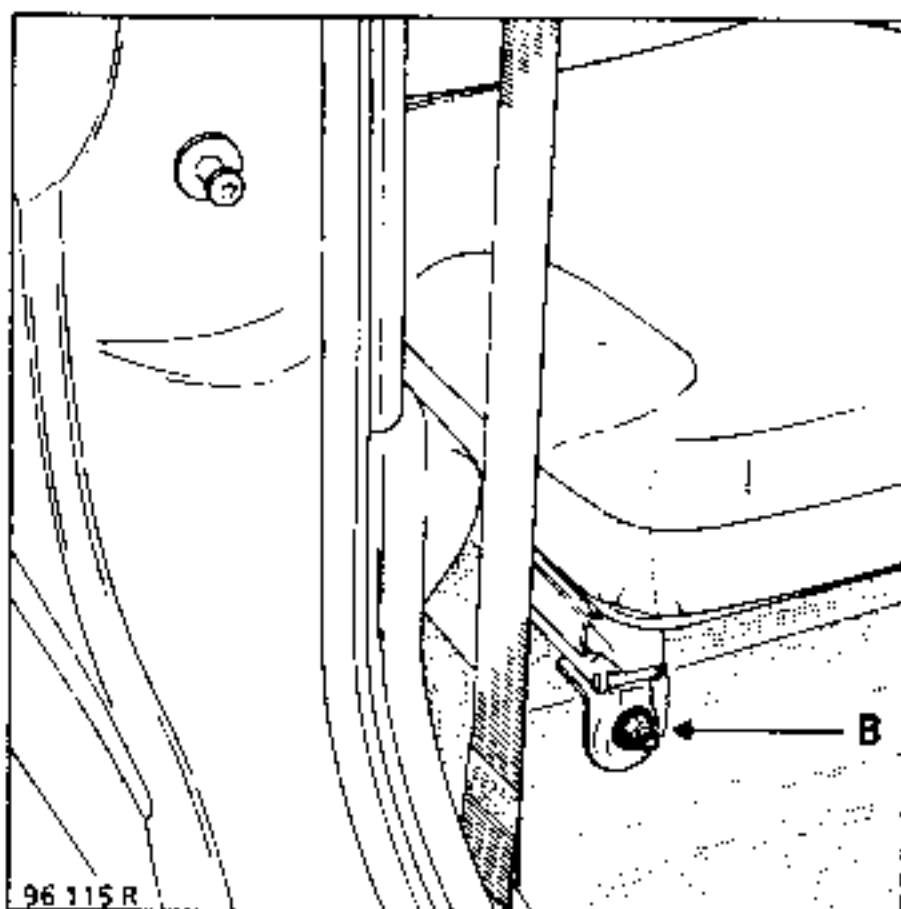

REFITTING

Reposition the rear bench seat.
Screw up the nuts (B) but do not fully tighten them.
Tilt the seat forwards.
Fit the safety lever.
Reposition and fit the retaining cable.
Fold the seat back down and ensure the lock engages
Once the seat is locked, tighten the two lock nuts to 2 daN.m.

IMPORTANT : (Each time the seat is removed)

The lock nuts should be replaced.

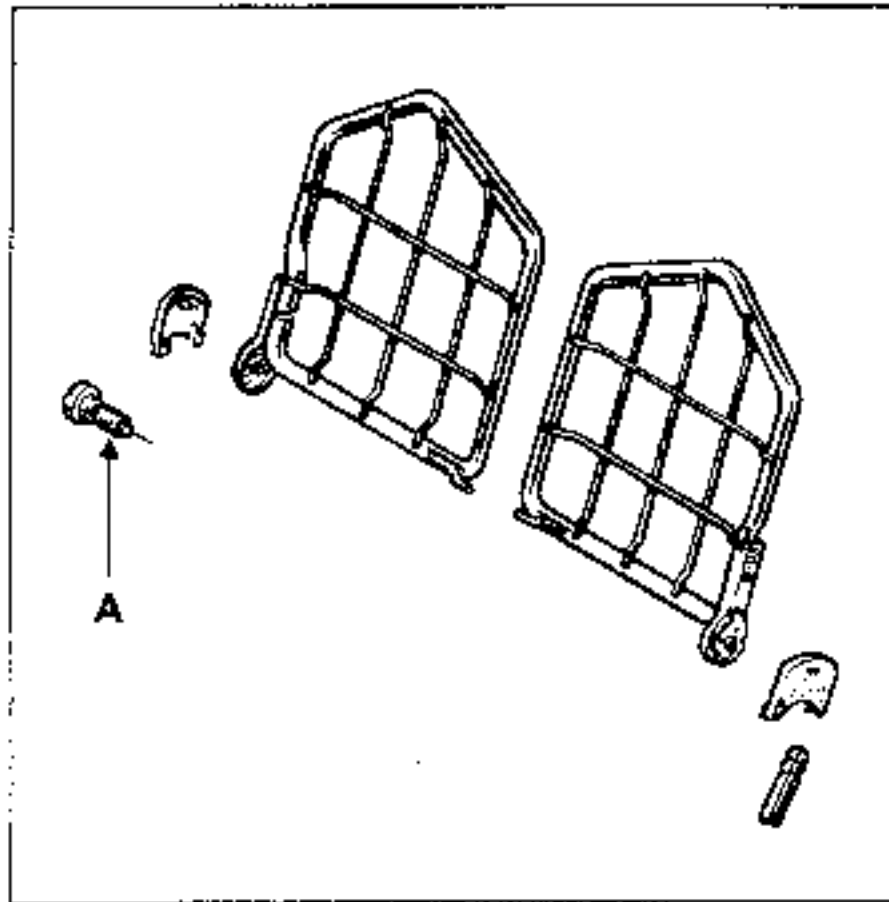

NOTE: The trim is sold fitted onto the frame

REMOVAL

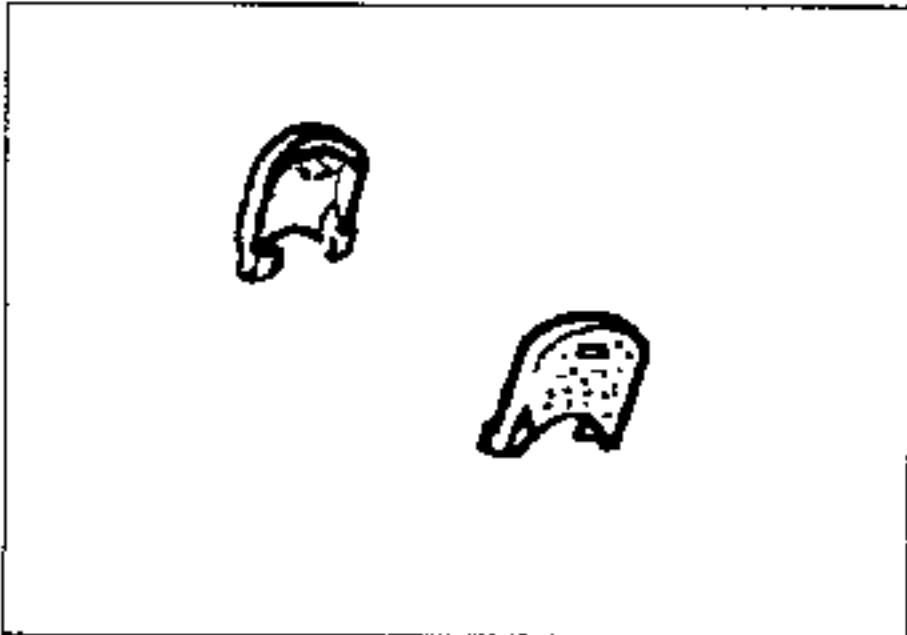

Unclip the two plastic seatback tilt mechanism covers

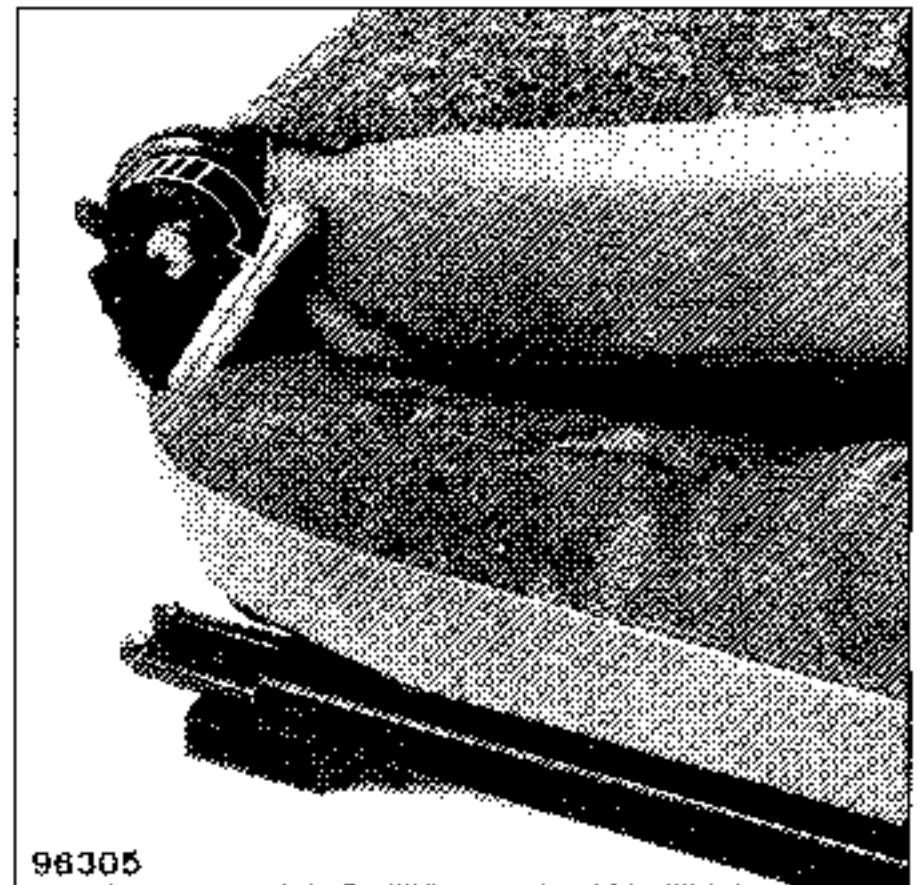

Tilt the seatbacks forward and remove the seatback mountings (A). One bolt per seatback section

Loosen the pivot while keeping the handle pressed forward (photo).

Remove the seatback sections by releasing them sideways

NOTE: When refitting the pivot hold the handle forward as for removal so the pivot is in the correct position

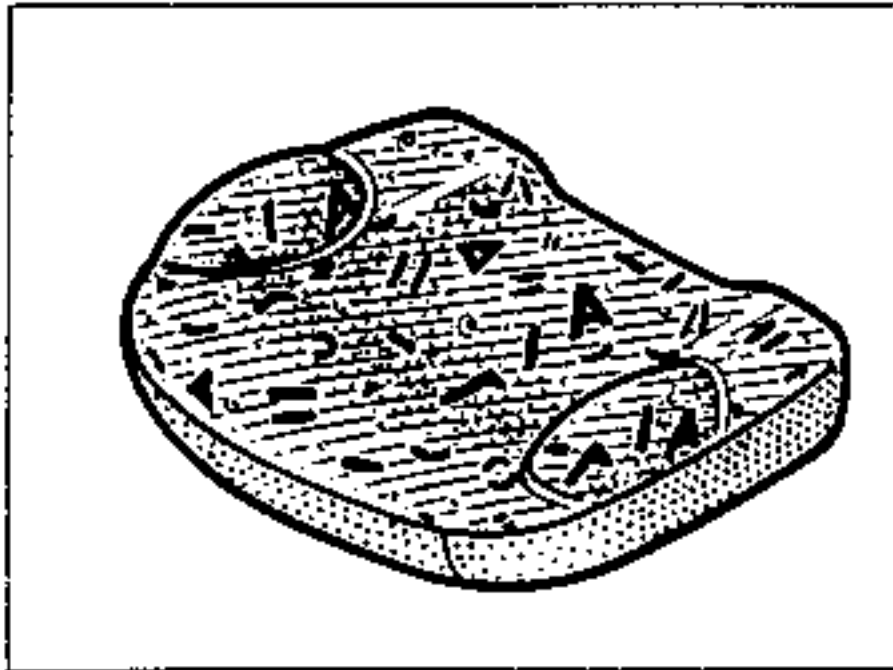

REMOVAL

NOTE: The trim and the foam form one part and are not sold separately.



After removing the seat, unclip the controls.

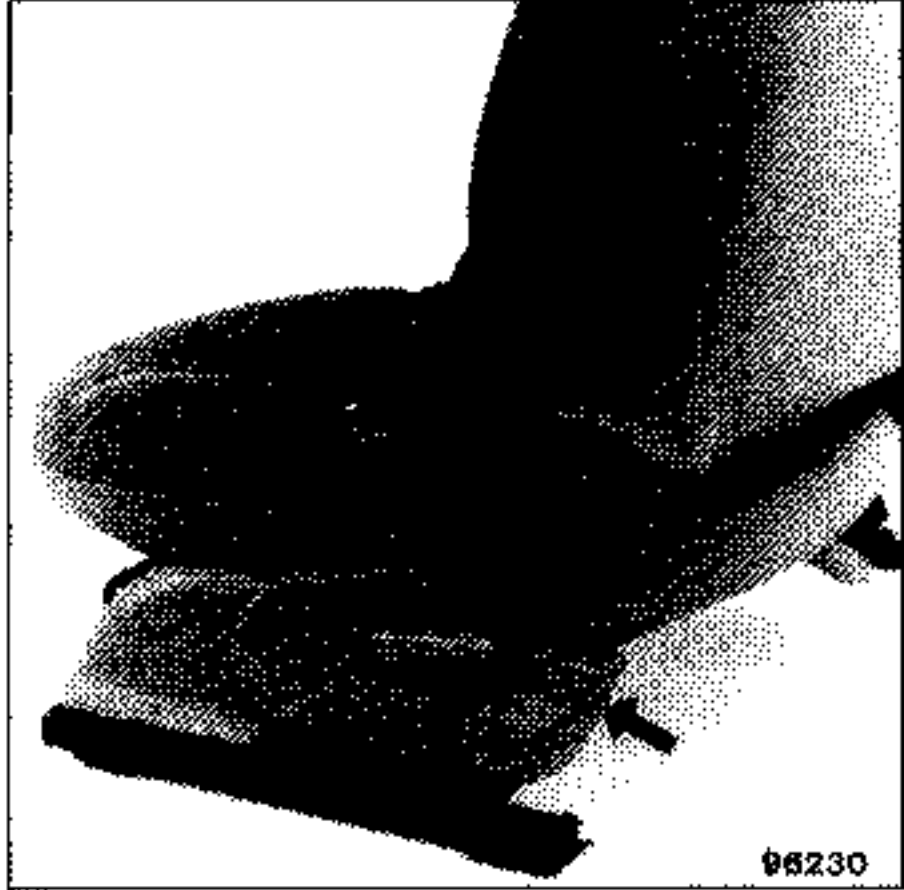

Remove the rear runner cover (two bolts)

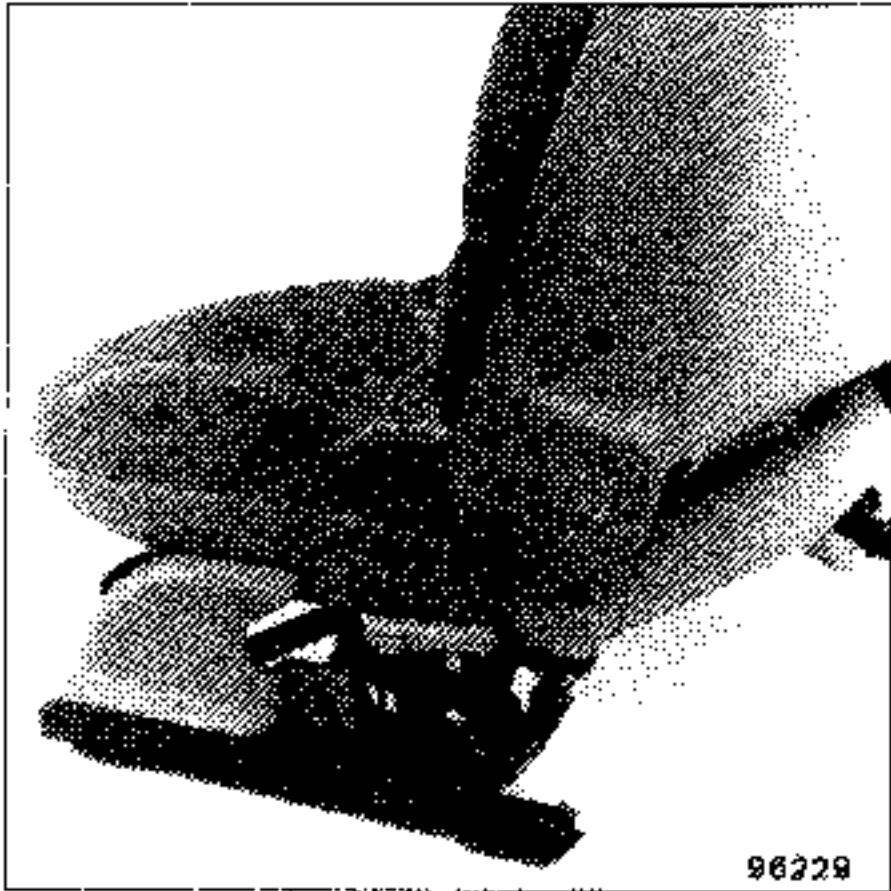

Remove the front runner cover (1 bolt).

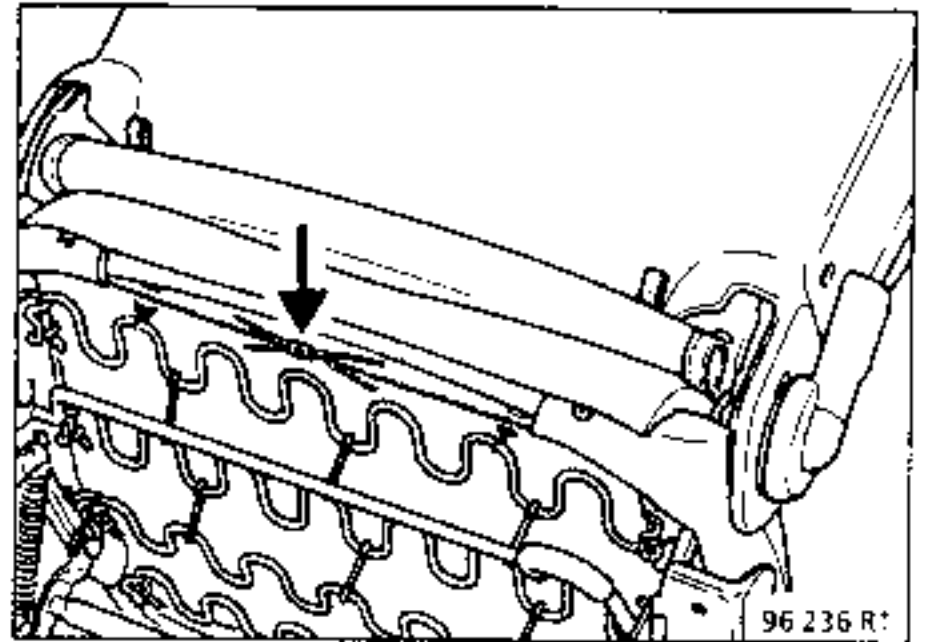

Undo the trim cord
Remove the trim and foam unit

Refitting:

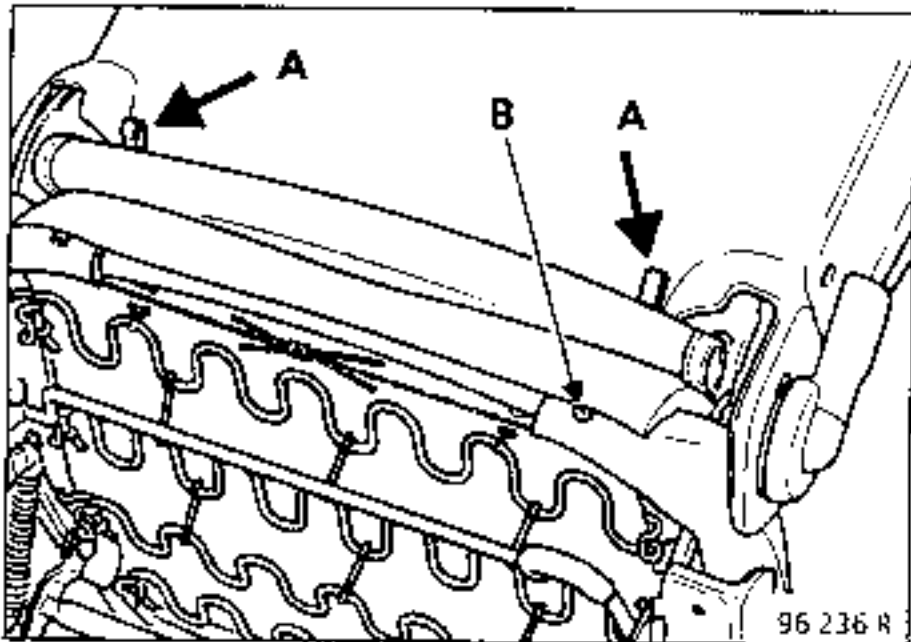

Cut the two clips (A) and remove the two other clips (B)

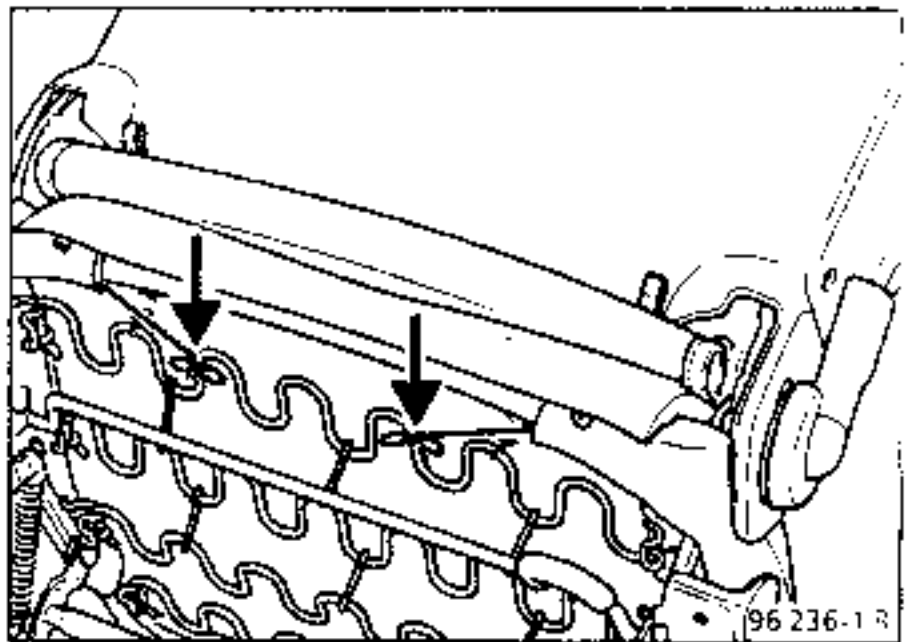

Pull the cord to tighten the edges of the trim and tie it.

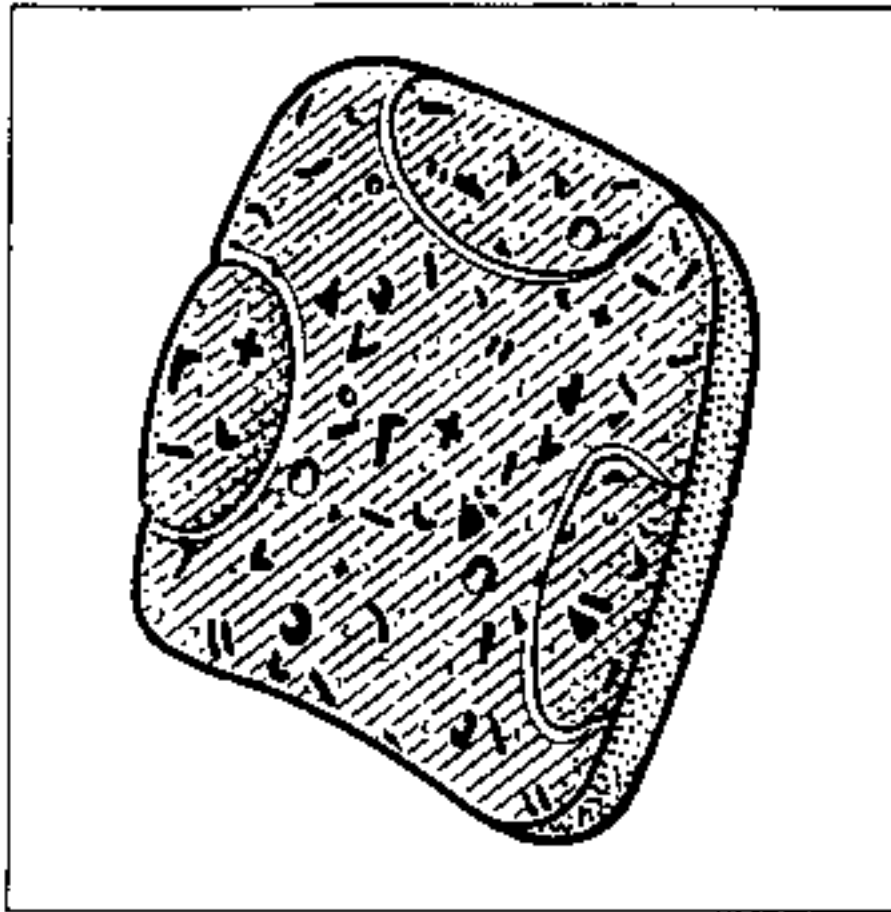

REMOVAL

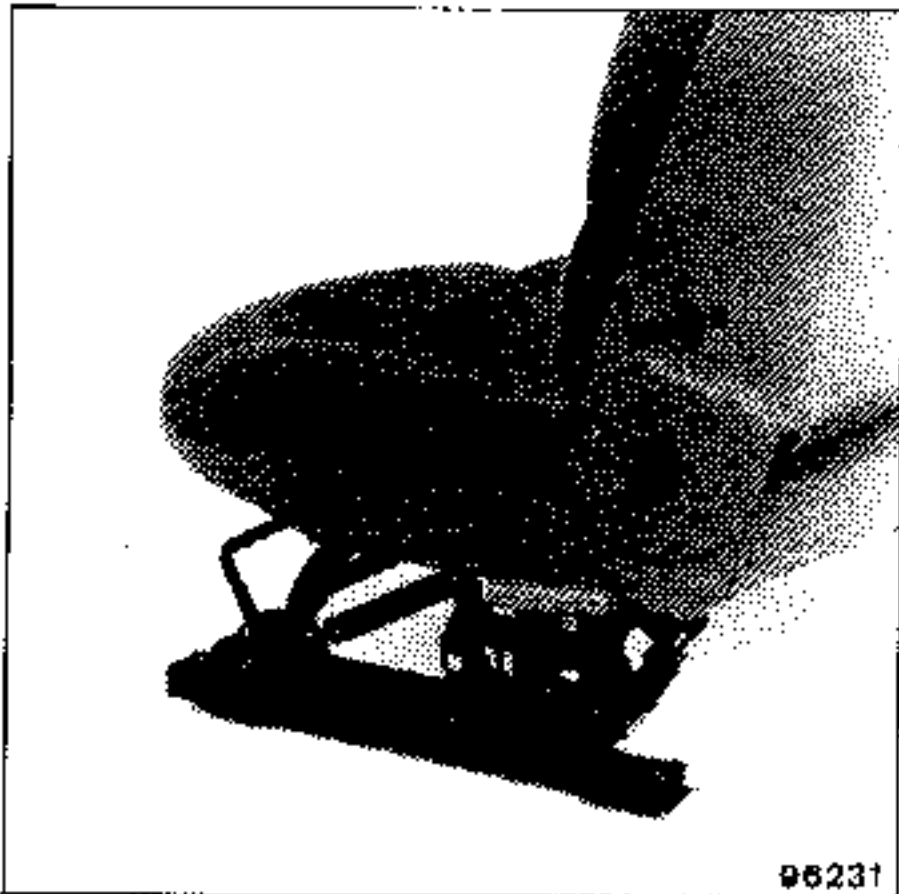

96231

Remove the plastic seatback mountings.
(1 bolt on each side)

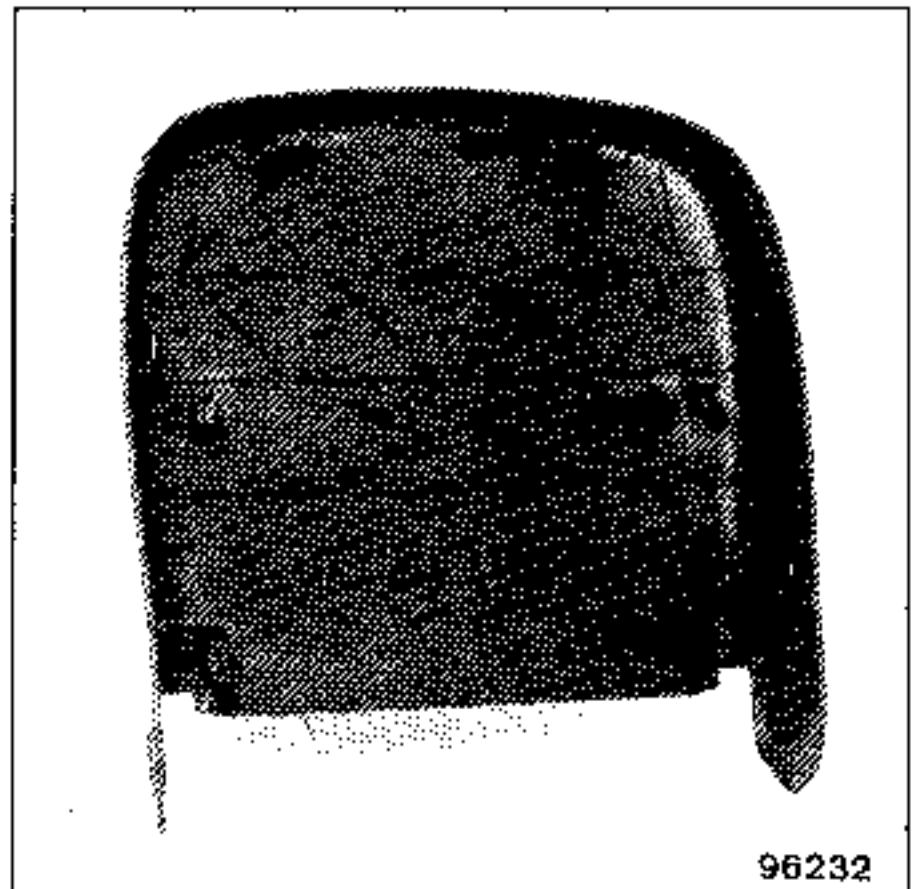

96232

Remove the plastic seatback by pushing it
upwards to remove the six hooks.

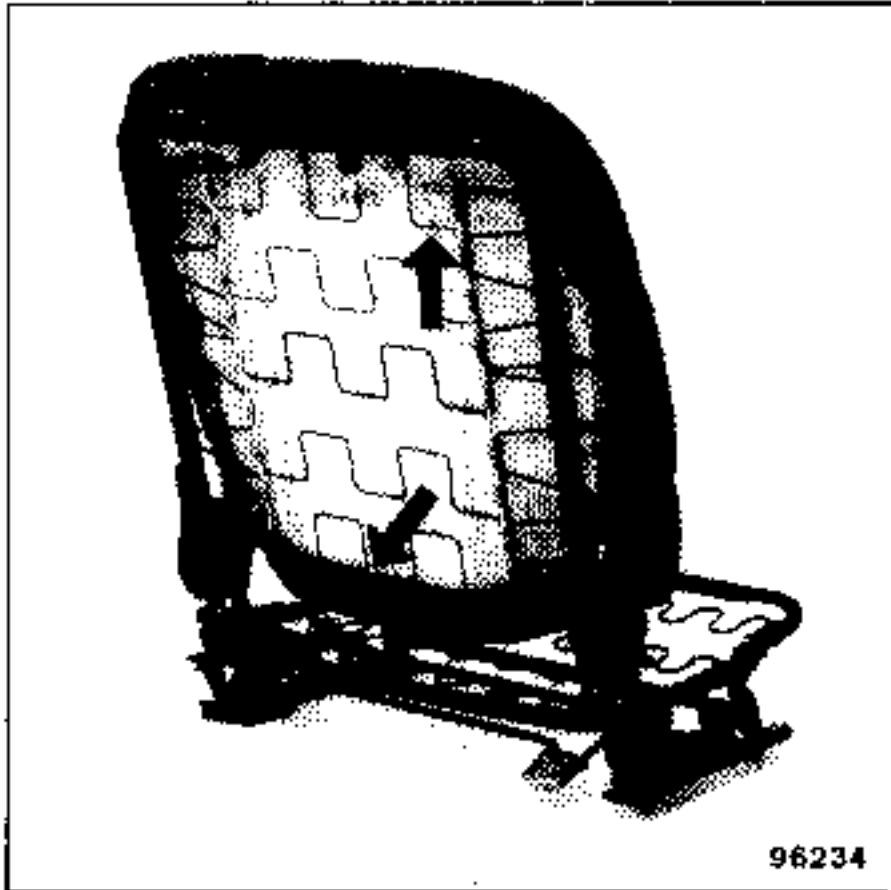

Cut the clips.

Undo the trim cord.

REMOVE THE TRIM AND FOAM UNIT.

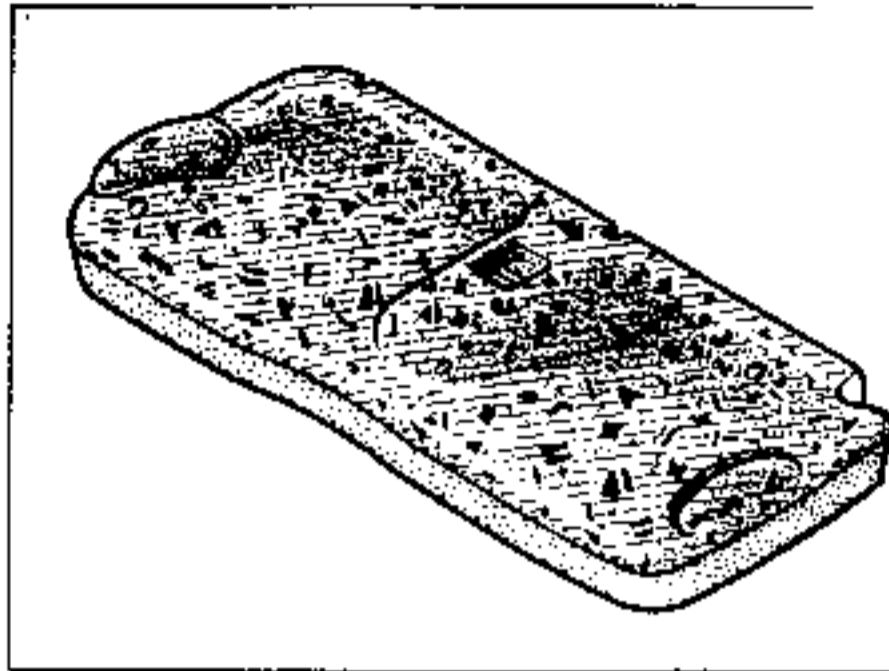

SAFETY: IMPORTANT : When refitting the seat the method, order of refitting and tightening torques must be observed.

REMOVAL

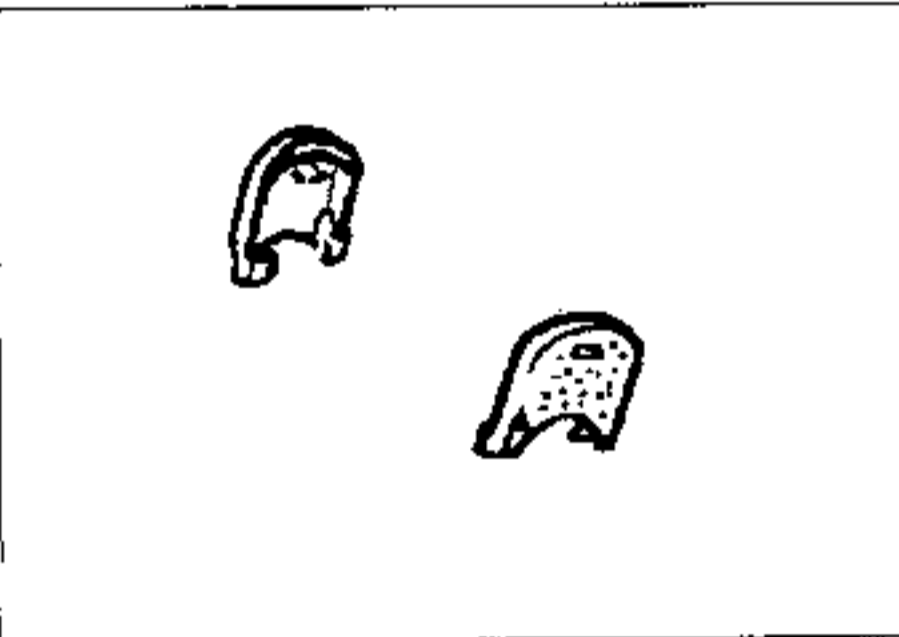

After removing the seat, unclip the two tilt mechanism plastic covers.

REMOVING THE SEATBACKS

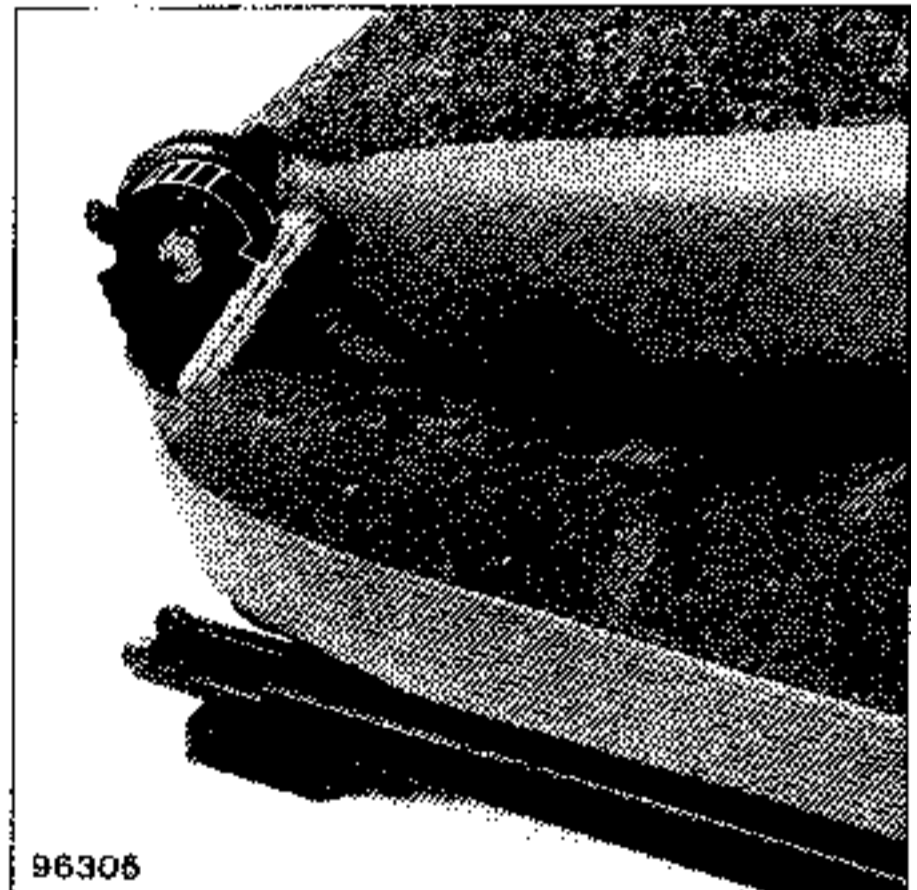

Tilt the seatbacks forward and remove the seatback mountings. One bolt per seatback section.

Loosen the pivot (B) while keeping the handle (C) pressed forward (photo).

Remove the seatback sections by releasing them sideways (D).

NOTE: When refitting the pivot hold the handle forward as for removal so the pivot is in the correct position.

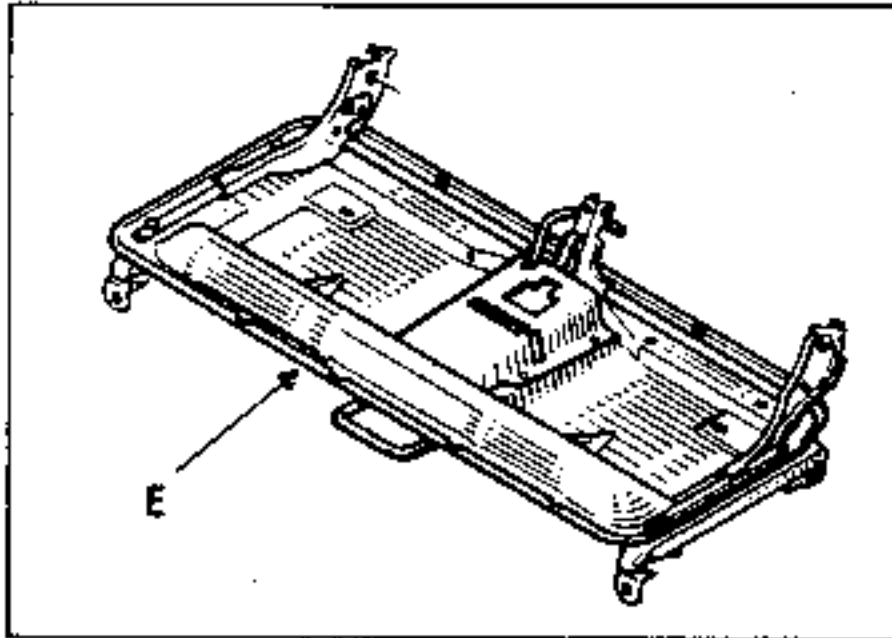

Open up the metal retaining clips on the edge of the frame (E)

Undo the trim cord and remove the trim and foam unit.

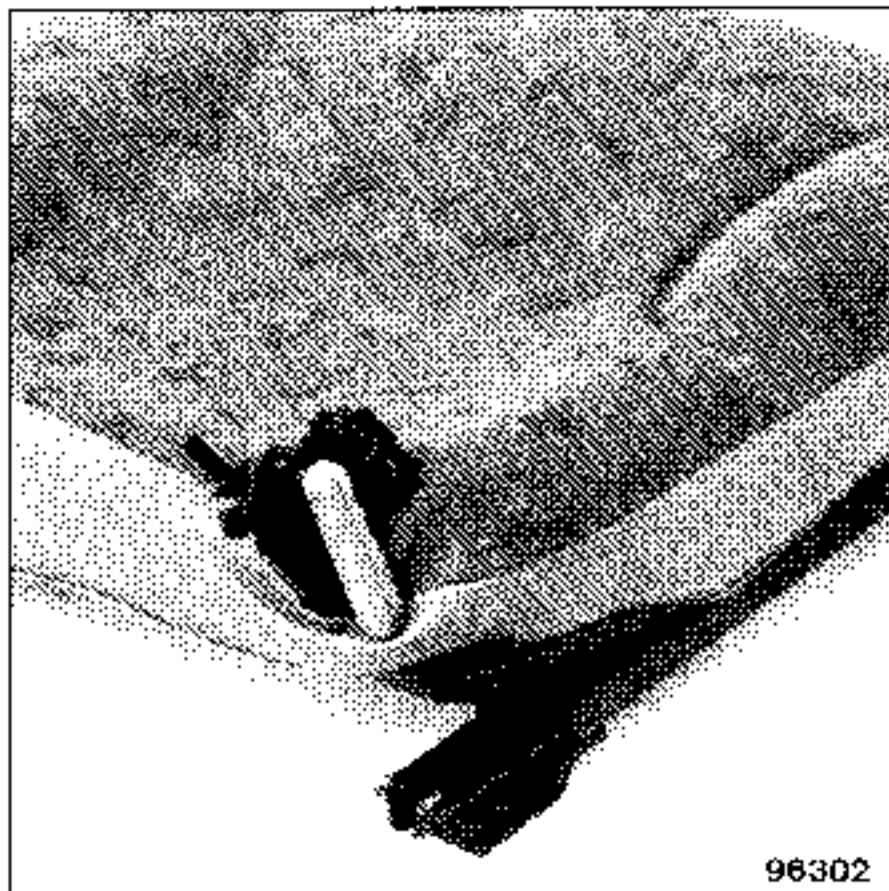

Take care not to damage this on the pivots

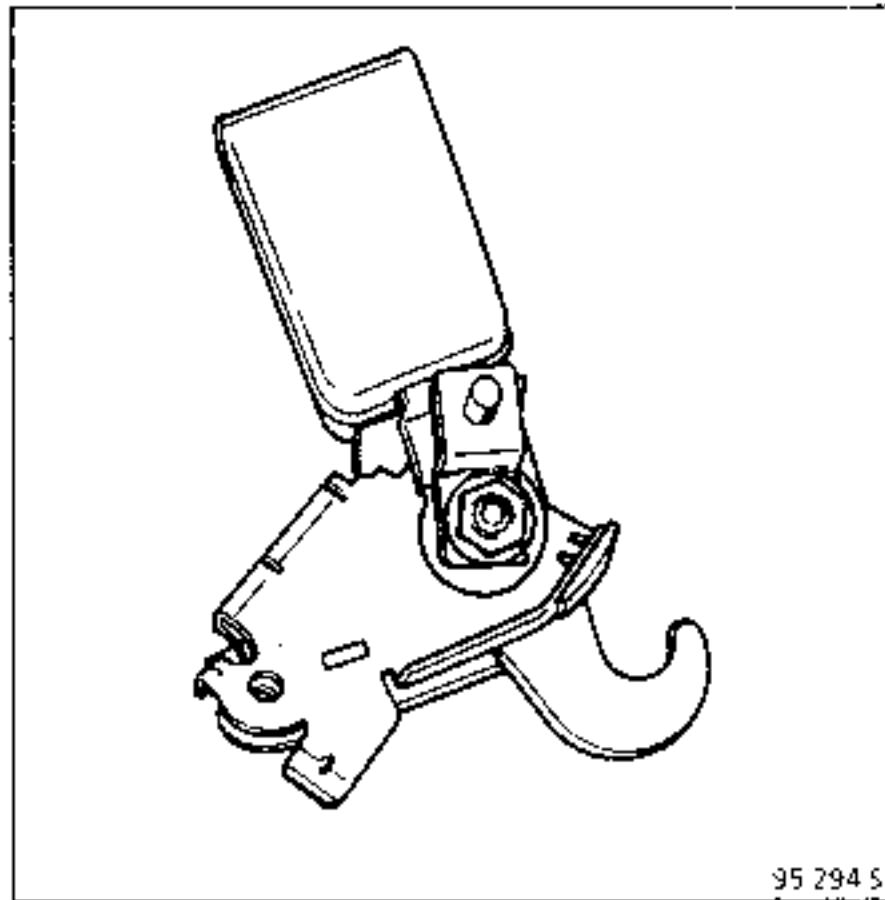

NOTE: When removing the rear seat belt stalks the same operation must be carried out.

REMOVAL

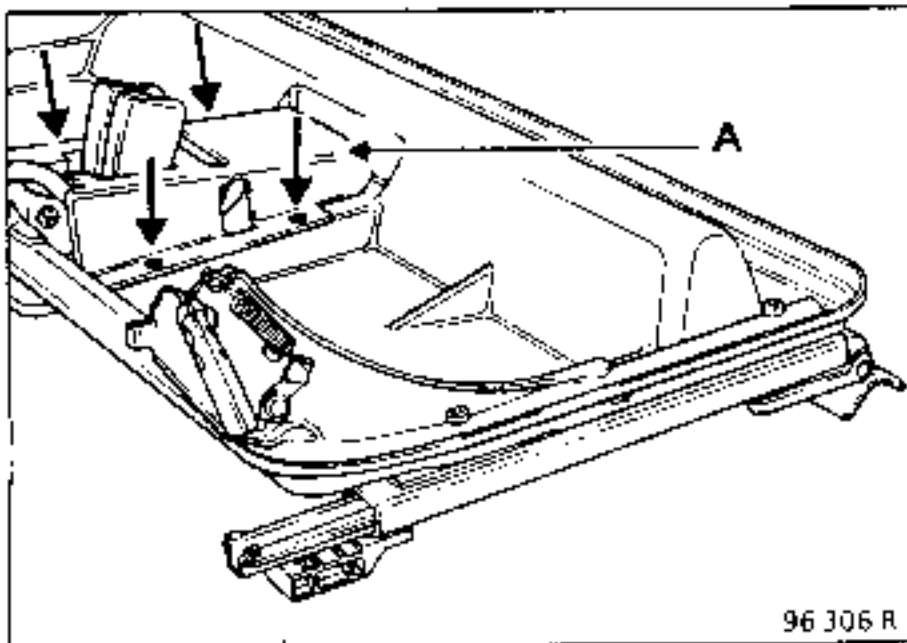

After removing the trim remove the 4 rivets securing the plastic casing (A)

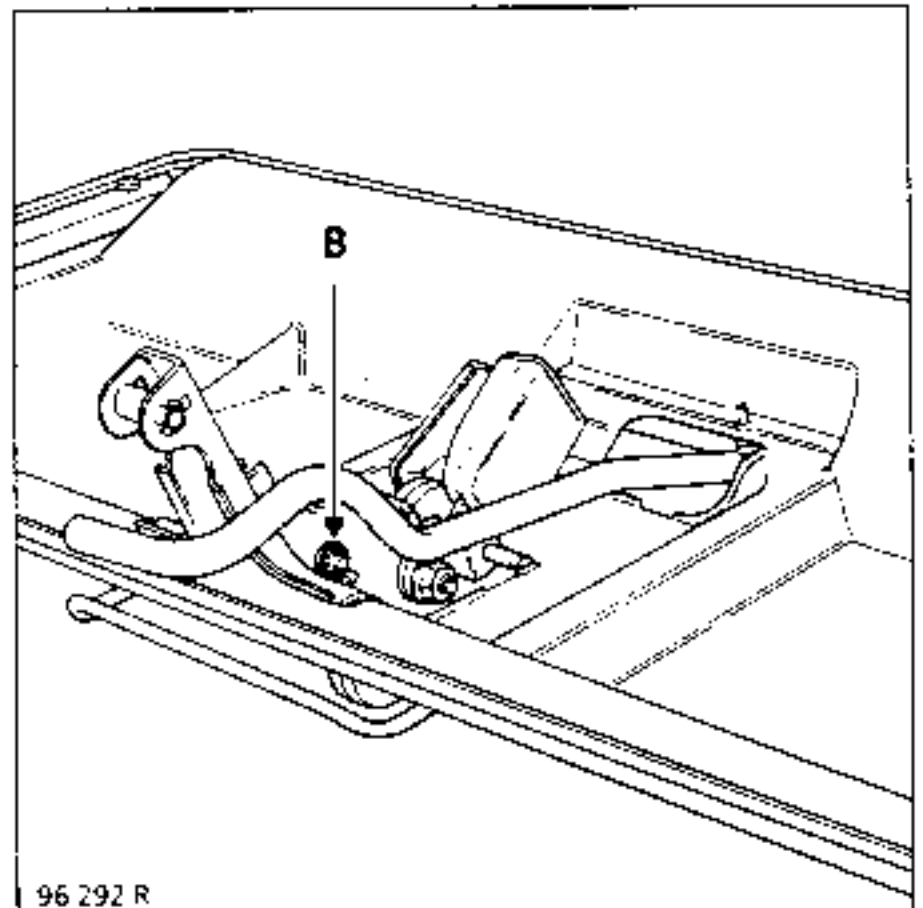

Remove the clips (B) noting the position of the spring. The clips must be renewed when refitting. Remove the shaft which is held in place by the clips.

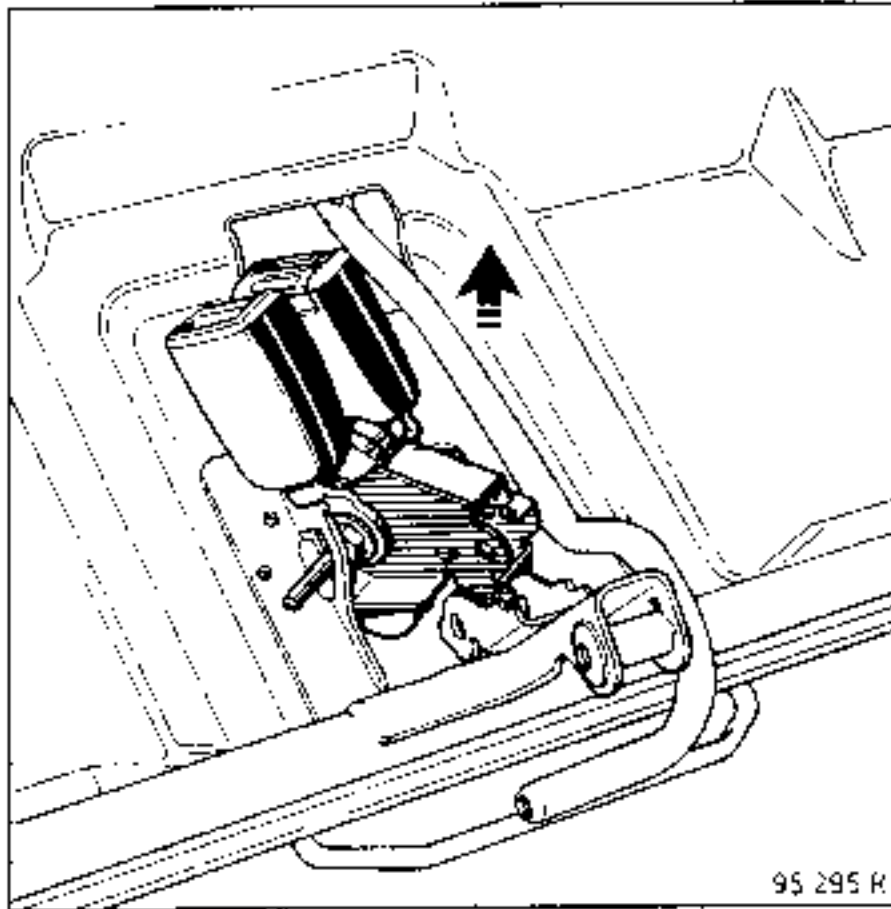

Remove the lock from the top as shown above.

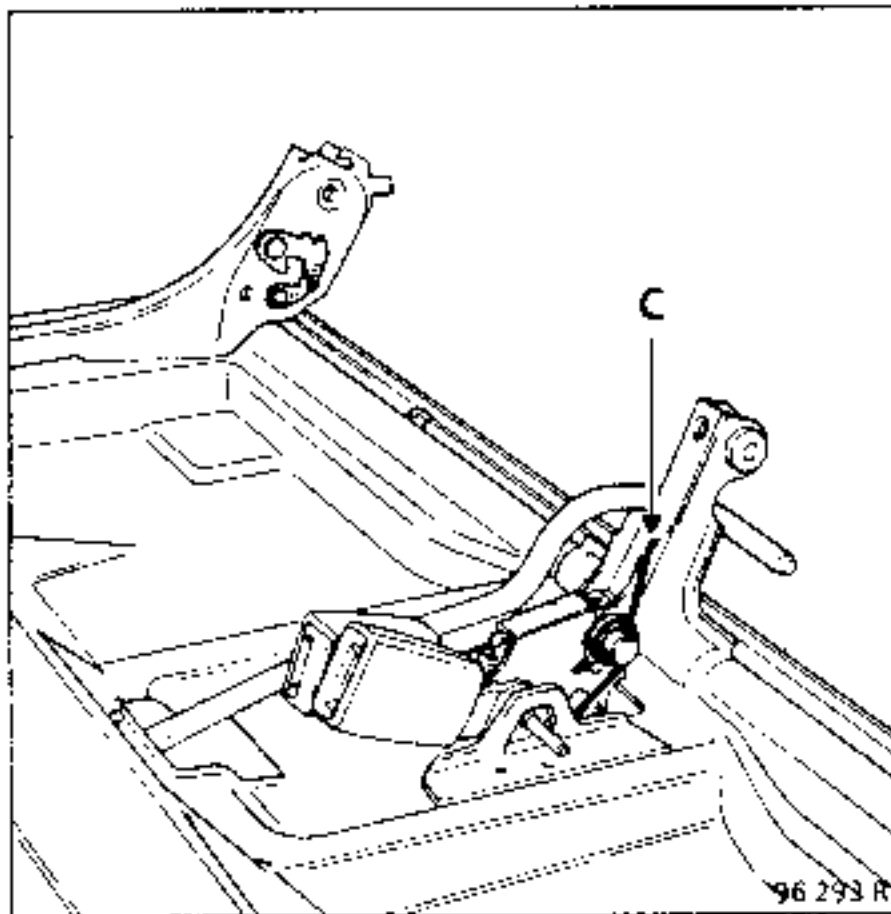

When refitting, ensure the spring is correctly repositioned (C)